

For years, *PANDUIT* has supplied its customers with innovative wire harness components, systems and installation tooling. *PANDUIT* offers a broad range of solutions to meet the changing challenges of routing wire in harness assembly production.

The *PANDUIT* Harness Board Accessories System has a unique product offering for all of your wire harness management needs. It provides for the fast routing and forming of wires in harness fabrication. The accessories hold the wires off the harness board at a uniform height for easy application of cable ties. For complete Harness Board System Solutions choose *PANDUIT* Harness Board Accessories, Cable Ties and Installation Tooling.



- One-stop-shopping for all your harnessing needs
- Speeds harness assembly while providing lowest installed cost
- Reduces operator fatigue
- Provides a higher quality finished product
- Makes it easy to install, maintain and modify the wire harness
- Enables greater design flexibility

**Contents**

**Page Number**

RER Type Replaceable Elastic Wire Retainers.....	3
ER Type Elastic Wire Retainers .....	3
BR Type Bundle Retainer .....	4
CPH Type Corner Post .....	4
CPL Type Corner Post (low) .....	4
WEH Type Wire End Holder .....	4
TJF Type T-Junction Fixture.....	5
Fanning Strip System .....	5
Spring Wire Breakout System .....	6
Harness Board Nails .....	6
Harness Board Platform .....	7
Harness Board Standoff Post .....	7
Tie Harness Mount Fixtures.....	8
Harness Board Universal Adapter.....	8
Tie Harness Anchor Universal Fixture.....	8
Tie Harness Mounts — Using Two Cable Ties .....	9
Installation System — PAT1M/PAT1.5M Reel Fed Systems for Harness Assemblies .....	10
<i>PANDUIT</i> ® Cable Ties .....	10

# PANDUIT® Harness Board Fixtures

## Wire Retainers —

### RER Replaceable Elastic Retainers

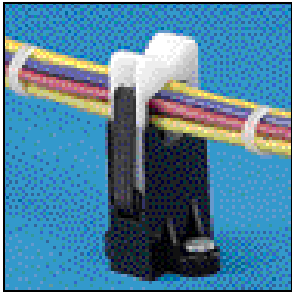

As wires are individually inserted, the bundle is pre-formed. When the harness is complete, it can be easily snapped out. Three sizes available for 1/2" (12.7mm), 3/4" (19.0mm) and 1 1/4" (31.7mm) bundles.

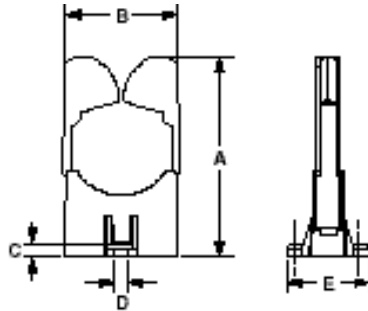

**Replacement Elastic**  
For economy, the elastic band can be replaced in the RER Elastic Retainers without removing the RER base.

Part Number	Pkg. Qty.
RER.5E-X	10
RER.75E-X	10
RER1.25E-X	10

Part Number	Max. Dia. In (mm)	Dimensions Inches (mm)					Material & Color	Mounting Method	Std. Pkg. Qty.	Std. Ctn. Qty.
		A	B	C	D	E				
RER.5-S6-X	.5 (12.7)	1.82 (46.2)	.84 (21.3)	.18 (4.7)	.141 (3.6)	1.18 (30.0)	Black Nylon and Acetal	#6 (M3) Screw	10	50
RER.75-S6-X	.75 (19.0)	2.12 (53.9)	1.12 (28.4)		.145 (3.7)				10	50
RER1.25-S6-X	1.25 (31.8)	2.75 (69.9)	1.64 (41.7)		.145 (3.7)				10	50

## ER Elastic Retainers

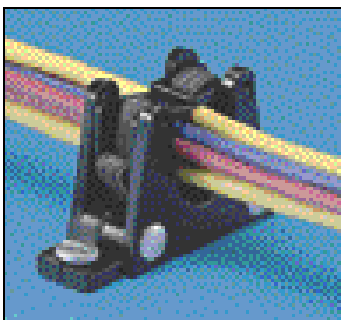

ER Type retainers form wire bundles as wires are inserted. Completed bundles then snap out. Two sizes available for 1/2" (12.7mm) and 1 1/4" (31.7mm) bundles.

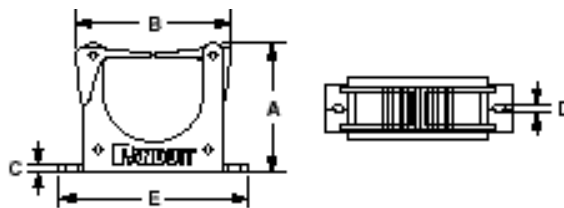

Part Number	Max. Dia. In (mm)	Dimensions Inches (mm)					Material & Color	Mounting Method	Std. Pkg. Qty.	Std. Ctn. Qty.
		A	B	C	D	E				
ER.5-E4-X	.5 (12.7)	1.00 (25.4)	1.00 (25.4)	.15 (3.8)	.120 (3.0)	1.90 (48.3)	Black Nylon and ABS	#4 (M2,5) Screws	10	100
ER1.25-E4-X	1.25 (31.8)	2.00 (50.8)	2.40 (61.0)		.120 (3.0)				2.90 (73.7)	10

## Bundle Retainers

Spring fingers with large lead in, facilitate fast routing of wires and easy removal of completed harness. Three sizes available for 1/2" (12.7mm), 3/4" (19.0mm) and 2.00" (50.8mm) bundles.

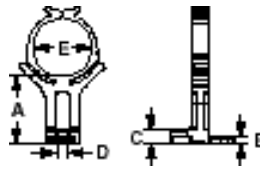
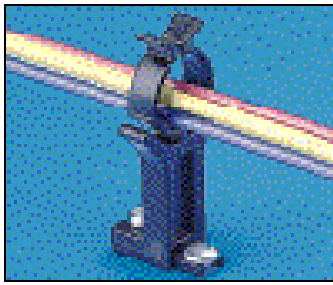

BR.5, BR.75,

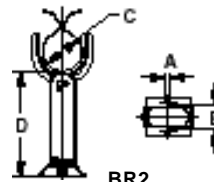

BR2

Part Number	Max. Dia. In (mm)	Dimensions Inches (mm)					Material & Color	Mounting Method	Std. Pkg. Qty.	Std. Ctn. Qty.
		A	B	C	D	E				
BR.5-E6-C	.5 (12.7)	1.07 (27.2)	.09 (2.3)	.20 (5.1)	.145 (3.7)	.52 (13.2)	Black Acetal	#6 (M3) Screws	100	500
BR.75-E6-C	.75 (19.0)	.95 (24.1)				.76 (19.3)			100	500
BR2-1.3-X	2.00 (50.8)	.27 (6.9)	1.23 (31.2)	2.12 (53.8)	1.30 (33.0)	—	Black Acetal	1.4" (6MM) Screw	10	100
BR2-1.3-A-X					1.30 (33.0)	—		Rubber Adhesive 2.0 lbs. Static Load	10	100
BR2-1.5-X	2.00 (50.8)	.26 (6.6)	1.42 (36.1)	2.12 (53.8)	1.62 (41.1)	—		1/4-20 (M6) Screws	10	100
BR2-4-X	2.00 (50.8)	.26 (6.6)	1.42 (36.1)	2.12 (53.8)	4.00 (101.6)	—			10	100
BR2-6-X	2.00 (50.8)	.26 (6.6)	1.42 (36.1)	2.12 (53.8)	6.00 (152.4)	—			10	100

## Corner Posts

Designed to pre-form bundles at harness corners and breakouts. The top arm pivots for easy removal of completed harness.

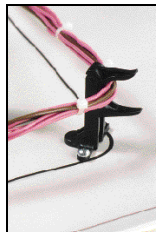

CPH Corner Post, High

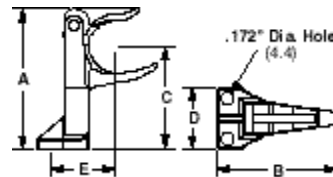

CPL Corner Post, Low

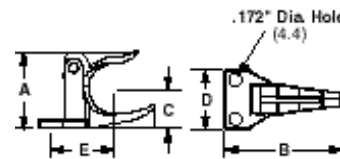

Part Number	Max. Dia. In (mm)	Dimensions Inches (mm)					Material & Color	Mounting Method	Std. Pkg. Qty.	Std. Ctn. Qty.
		A	B	C	D	E				
CPH.75-S8-X	.75 (19.0)	1.78 (45.3)	1.60 (40.8)	1.35 (34.4)	.90 (22.9)	1.18 (30.0)	Black Acetal	#8 (M4) Screws	10	100
CPL.75-S8-X		1.08 (27.4)	1.52 (38.6)	.56 (14.2)	.88 (22.4)	1.11 (28.2)			10	100

## Wire End Holder

Secures wire ends with or without terminations while harness is being fabricated. Wires can be easily added or removed from the top, but will hold the wire from axial movement. Used with #28 thru #16 AWG wires. Two mounting slots .16" (4.1mm) for #8 (M4) screws.

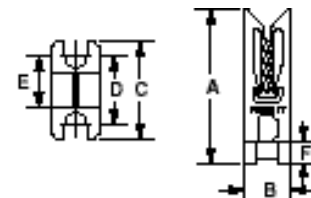

Part Number	Dimensions Inches (mm)						Material & Color	Mounting Method	Std. Pkg. Qty.	Std. Ctn. Qty.
	A	B	C	D	E	F				
WEH-E8-C	1.25 (31.8)	.38 (9.7)	.79 (20.0)	.55 (14.0)	.29 (7.4)	.18 (4.6)	Black Acetal	#8 (M4) Screws	100	1000

## T-Junction Fixture

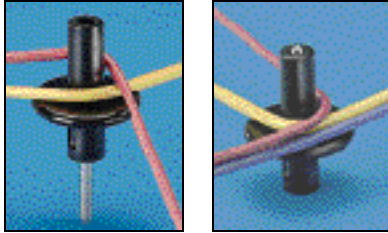

The "up" position allows forming of harness and cable tie installation

The "down" position allows easy harness removal.

Using an integral harness board nail, the fixture moves up and down (see photos) to form "T" junction. Unique design reduces cable tie usage by 1/3 compared to other fixtures.

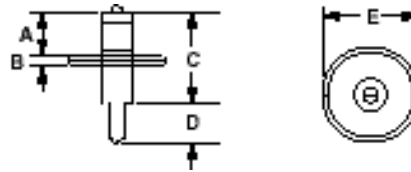

Part Number	Max. Dia. In (mm)	Dimensions Inches (mm)					Material & Color	Mounting Method	Std. Pkg. Qty.	Std. Ctn. Qty.
		A	B	C	D	E				
TJF-X	1.34 (34.0)	.75 (19.1)	.12 (3.0)	1.39 (35.1)	.70 (17.8)	1.12 (28.4)	Black Acetal and Nickel Plated Steel	Integral Nail	10	100

## Fanning Strip System

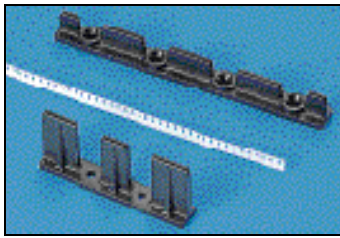

Assures that wires are held in a particular orientation in sophisticated wiring harnesses. Consists of fanning strip and fanning strip holder.

Part Number	Dimensions Inches (mm)						Material & Color	Mounting Method	Std. Pkg. Qty.
	A	B	C	D	E	F			
FS156-C	12.0 (304.8)	.31 (7.9)	.04 (1.0)	.12 (3.0)	.156 (4.0)	.06 (1.5)	Nylon	Fanning Strip Holder	100
FSH40-X	6.0 (152.4)	.62 (15.7)	.56 (14.2)	1.50 (38.1)	.75 (19.0)	.04 (1.0)	ABS	#8 (M4) Screw	10
FSHH-X	3.22 (82)	1.38 (35.1)	.57 (14.5)	1.12 (28.4)	.53 (13.5)	.04 (1.0)	ABS		10

### Fanning Strip (FS156)

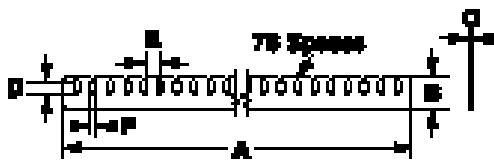

Contains evenly spaced "snap slots" to hold wires in place. No sharp edges to damage wire insulation. Becomes part of the wiring harness. Will accept wires up to 18 AWG. Used with FSH40 or FSHH holders.

### Low Holder (FSH40-X)



Designed to hold FS156 Fanning Strip securely in place while wires are inserted into fanning strip.

### High Holder (FSHH-X)

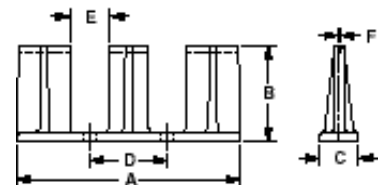

Used in conjunction with RER.75-S6, BR.75-E6 (BR.5-E6) and CPH.75-S8. Ideal for use with PAT cable tie tool. (See Page 10.)

# Spring Wire Breakout System

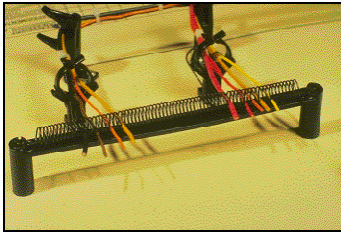

Consists of harness board springs and spring holders to hold wire ends taut. When harness is removed from board, wires simply pull from spring.

## PBSC Spring Wire Breakout



## SHH Spring Holder

Each SHH Spring Holder is supplied with (1) rigid wire piece to hold the spring laterally and two #8 (M4) 2" (50.8mm) hex head wood screws. Two sizes available for use with PBSC1 and PBSC6.

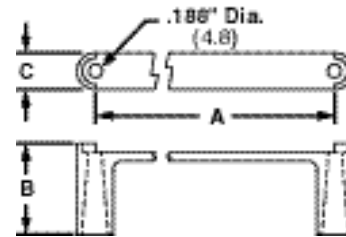

Part Number	Dimensions Inches (mm)			Material & Color	Mounting Method	Packaging	
	A	B	C			Std. Pkg. Qty.	Std. Ctn. Qty.
PBSC1-X	1.00 (25.4)	.44 (11.2)	—	.035" (.9) Thick Steel	Used with SHH1 Spring Holder	10	100
PBSC3-X	3.00 (76.2)		—		—	10	100
PBSC6-X	6.00 (152.4)		—		Used with SHH3 Spring Holder	10	100
PBSC12-X	12.00 (304.8)		—		—	10	—
SHH1-S8-X	1.90 (48.3)	1.30 (33)	.50 (12.7)	Nylon	Two #8 (M4) 2" (50.8) Screws used with PBSC1	10	—
SHH3-S8-X	7.00 (177.8)				Two #8 (M4) 2" (50.8) Screws used with PBSC6	10	—

# Harness Board Nails

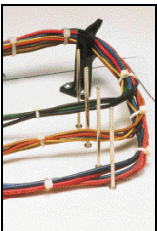

Speeds routing of wires. All have a uniform driving depth insured by collar stop.

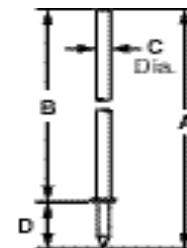

Part Number	A	B	C	D	Material	Mounting Method	Std. Pkg. Qty.	Std. Ctn. Qty.
HBN.75-T	1.40 (35.6)	.78 (19.8)	.073 (1.9)	.62 (15.9)	Hardened Tempered Steel	Hammered into Harness Board	200	1000
HBN1-T	1.65 (41.9)	1.03 (26.2)	.073 (1.9)				200	1000
HBN1.5-T	2.15 (54.6)	1.53 (38.4)	.082 (2.1)				200	1000
HBN2-T	2.65 (67.3)	2.03 (51.6)	.093 (2.4)				200	1000
HNB2.5-T	3.17 (80.5)	2.55 (64.8)	.110 (2.8)				200	1000
HBN3-T	3.67 (93.2)	3.05 (77.5)	.120 (3.0)				200	1000
HBN4-T	4.67 (118.6)	4.03 (102.9)	.144 (3.7)				200	1000

## Harness Board Platform

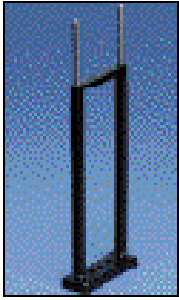

Elevates the bundle of wires from the harness board to allow the installation of Abrasion Protection products and the use of *PANDUIT* automatic cable tie tools. The platform is used as a template to mark the location of the nails. The nails are driven into the board with a hammer. The plastic sleeve slides over each nail.

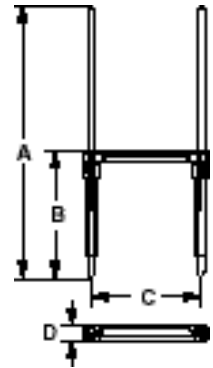

Part Number	Max. Bundle Dia. In (mm)	Dimensions Inches (mm)				Material	Mounting Method	Packaging	
		A	B	C	D			Std. Pkg. Qty.	Std. Ctn. Qty.
HB1P4-X	1.00 (25.4)	5.00 (127.0)	4.00 (101.6)	1.32 (33.5)	.375 (9.5)	Nylon platform, vinyl spacer, tempered steel nails	Driven into harness board	10	100
HB1P6-X		7.00 (203.2)	6.00 (152.4)					10	100
HB2P4-X	2.00 (51)	6.00 (152.4)	4.00 (101.6)	2.32 (58.9)				10	100
HB2P6-X		8.00 (203.2)	6.00 (152.4)					10	100

## Harness Board Standoff Post

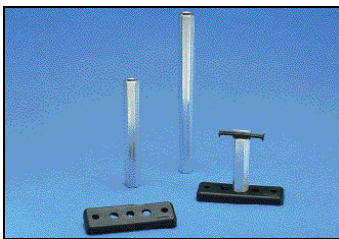

Used to hold a push mount accessory or push mount cable tie at a specific location on a harness board. The Standoff Post is placed over a hole in the harness board, a bolt is then threaded into the bottom of the standoff from the backside of the board and tightened. Push mount accessories are inserted into the top of the Standoff Post prior to assembly. When the assembly is complete, the harness and the attached push mount are removed from the Standoff Post.

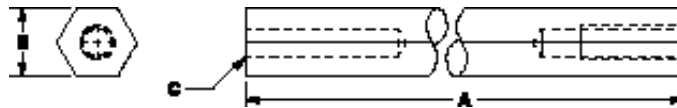

Part Number	Dimensions Inches (mm)			Material	Mounting Method	Std. Pkg. Qty.	Std. Ctn. Qty.	
	A	B	C					
HB2SP19-X	2.00 (51)	.50 (12.7)	.203 (5.1)	Aluminum	(M6) Screw	10	100	
HB4SP19-X	4.00 (101.6)					.295 (7.5)	10	100
HB6SP19-X	6.00 (152.4)						10	100
HB2SP25-X	2.00 (51)		10				100	
HB4SP25-X	4.00 (101.6)							
THMSPXX-C							(See Page 9 for Complete Description)	
THMSCXX-C								

THMSC—Tree Barb Style

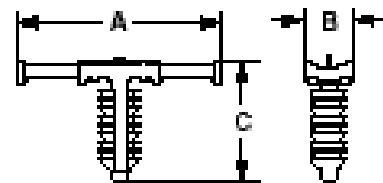

THMSP—Push Barb Style

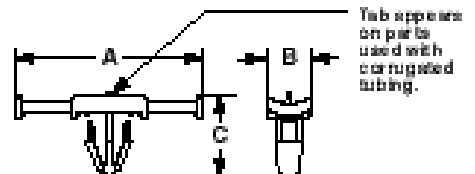

## Tie Harness Mount Fixture

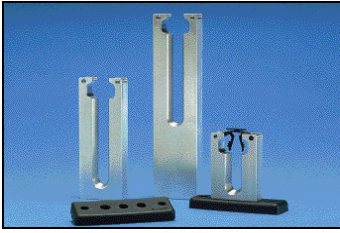

Used to hold and support the THM1SC Harness Mount. The mount is elevated from the harness board so that a cable tie can be installed by Panduit's automatic cable tie installation tools. The mount is pushed into the top of the fixture prior to assembly and pulled out of the fixture when the harness is complete.

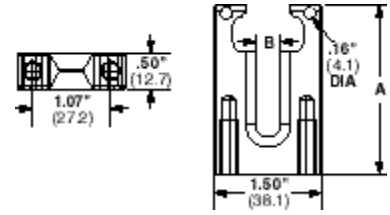

THMF

Part Number	A	B	C	Material	Mounting Method	Std. Pkg. Qty.	Std. Ctn. Qty.
THMF2-X	2.08 (52.8)	.28 (7.1)	—	Aluminum	(M6) Screw	10	50
THMF4-X	4.08 (103.6)	.34 (8.7)	—			10	50
THMF6-X	6.08 (154.4)	.34 (8.7)	—			10	50
THM1SC-C				Nylon (Natural Color)	Push	100	1000
THM1SC-C69	.98 (24.8)	.38 (9.5)	.75 (19.1)	Black			

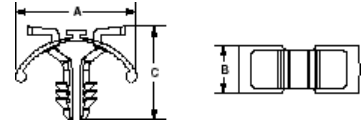

THM1SC

## Harness Board Universal Adapter

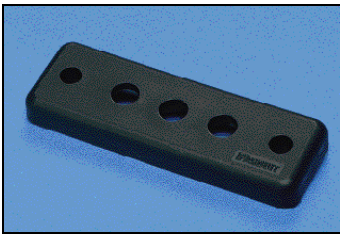

Used with the Harness Board Standoff Post or the Harness Mount Fixture when mounting holes can not be drilled into the harness board. A bolt is inserted from the back side of the adapter and then is turned right side up. The adapter is now ready to be secured to the harness board by using self tapping screws.

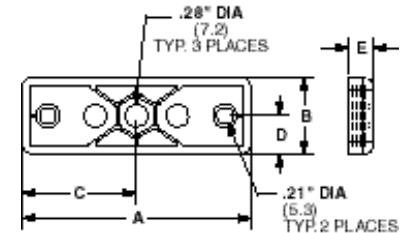

Part Number	A	B	C	D	E	Material & Color	Mounting Method	Std. Pkg. Qty.	Std. Ctn. Qty.
HBUA-X	3.00 (77)	1.00 (25.4)	1.50 (38.1)	.50 (12.7)	.31 (7.9)	Black Nylon	Wood Screw	10	100

# Tie Harness Mounts — Using Two Cable Ties



Tie Harness Mounts are designed to be attached to the wire harness during assembly with 2 cable ties. Ties can be installed by hand or, more efficiently, with *PANDUIT* Automatic Cable Tie Tooling. Use with Harness Board Standoff Posts and Tie Harness Mount Fixtures (See pages 7 & 8). Available with or without corrugated tubing location tab.

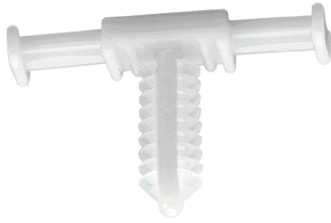

THMSC



THMSP

THMSC—Tree Barb Style

THMSP—Push Barb Style

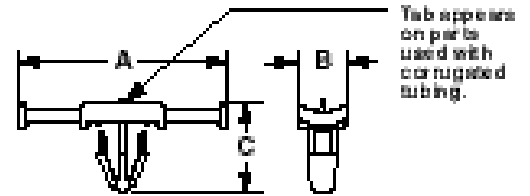
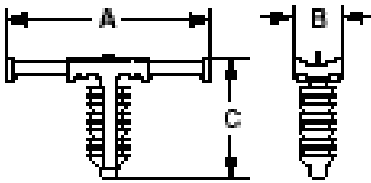

Part Number	Used With Cable Ties**	Dimensions inches (mm)				Panel Dimensions		Material	Color	Where Used	Mounting Method	Packaging					
		A	B	C	D	Thickness Max.	Hole Diameter					Std. Pkg. Qty.	Std. Ctn. Qty.	Bulk Pkg. Qty.	Bulk Ctn. Qty.		
<b>TREE MOUNT STYLE FOR CORRUGATED TUBING</b> —A specially designed location tab on the mount shelf aligns with grooves in corrugated tubing ensuring proper mount location during assembly.																	
THMSC35-C639	M, I, S	1.54 (39.1)	.37 (9.5)	.46 (11.7)	—	.25 (6.4)	.244 - .268 (6.2 - 6.8)	Heat Stabilized Nylon	Natural Black	Indoors/ High Temp.	Tree Barb	100	1000	1000	5000		
THMSC35-C630												100	1000	1000	5000		
<b>FOR DISCRETE WIRING</b> —There is no location tab for applications not requiring the use of corrugated tubing.																	
THMSP20F-C	M, I, S	1.54 (39.1)	.37 (9.5)	.47 (11.9)	—	.16 (4.1)	.244 - .283 (6.2 - 7.2)	Nylon	Natural	Indoors	Push Barb	100	1000	1000	5000		
THMSP20F-C30								Heat Stabilized Nylon	Black	Indoors/ High Temp.		100	1000	1000	5000		
THMSP25F-C				.54 (13.7)	—	.23 (5.8)		Nylon	Natural	Indoors		100	1000	1000	5000		
THMSP25F-C30								Heat Stabilized Nylon	Black	Indoors/ High Temp.		100	1000	1000	5000		

Cable Tie Cross Section Sizes: M = Miniature, I = Intermediate, S = Standard, LH = Light Heavy and H = Heavy.



## PAT1M/PAT1.5M Automatic Cable Tie Installation System

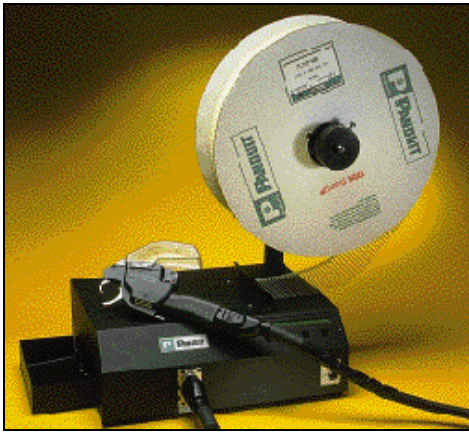

- System consists of a tool head, dispenser, feeder hose and reel of continuously molded cable ties (5000 per reel).
- System installs a cable tie in less than one second
- On-line help menu in English, Spanish, French, German or Italian
- Adjustable tension control
- Ergonomic and lightweight, no counter balance required
- Optional bench mount available

Part Number	Description	Std. Pkg. Qty.
PAT1M	Tool head for cable ties up to .82" (21mm) bundle diameter	1
PAT1.5M	Tool head for cable ties up to 1.3" (33mm) bundle diameter	
PDM	Stationary dispenser	1
PHM1	3.2 ft (1m) feeder hose	1
PHM2	6.5 ft (2m) feeder hose	
PHM3	9.8 ft (3m) feeder hose	
PATMBM	Bench mount and foot pedal for PAT1M/PAT1.5M system	1
PDH10-37	Airline	1
PL283N1	Filter regulator	1

- Slim, ergonomically designed handle for operator comfort and greater productivity
- Right or left hand operation

## PANDUIT® Cable Ties — World Leader in Cable Ties and Harness Board Accessories

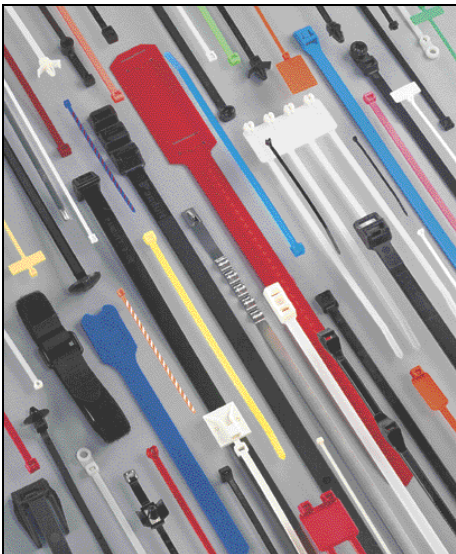

Panduit is the world's largest producer of cable ties and accessories, offering you the most complete selection of sizes, styles and materials. For harness manufacturing applications, *PANDUIT's* complete system of cable ties, harness board accessories and installation tooling provides the highest quality at the lowest installed cost. In addition, *PANDUIT* continually develops new cable tie and harness board accessories to meet your changing application challenges.

*PANDUIT* Cable Ties, Accessories and Installation Tooling are manufactured in an environment committed to design innovation, high quality and knowledgeable service to our customers. *PANDUIT* Cable Ties, Harness Board Accessories and Tooling provide system solutions for fast routing and forming as well as reliable and economical installations.

For more than 45 years, *PANDUIT* offers you the complete system for successful harness applications.

# It's Easy to Obtain **PANDUIT®** Products

## Just Call Your Panduit Sales Office Listed Below for the Names of Distributors Near You

<b>ALABAMA</b> Birmingham (205)290-2703 Huntsville (888) 506-5400	<b>MAINE</b> (888) 506-5400	<b>NORTH CAROLINA</b> Greensboro (336)854-1626
<b>ALASKA</b> Anchorage (907)562-5663	<b>MARYLAND Eastern</b> Baltimore (888) 506-5400	<b>NORTH DAKOTA</b> Minneapolis, MN (612)946-9510
<b>ARIZONA</b> Gilbert (888)506-5400	<b>MARYLAND Western</b> Pittsburgh, PA (412)486-8488	<b>OHIO</b> Cincinnati (888) 506-5400 Cleveland (888) 506-5400 Columbus (614)888-6224
<b>ARKANSAS</b> Little Rock (501)455-4506	<b>MASSACHUSETTS Eastern</b> N. Andover (978)681-0451	<b>OKLAHOMA</b> Oklahoma City (405)842-8371
<b>CALIFORNIA</b> Cupertino (408)342-1200 Santa Fe Springs (562)921-4423 Sacramento (530)885-6591	<b>MASSACHUSETTS Western</b> (888) 506-5400	<b>OREGON</b> Portland (888) 506-5400
<b>COLORADO</b> (888) 506-5400	<b>MICHIGAN</b> Detroit (248)577-5376 Grand Rapids (888) 506-5400	<b>PENNSYLVANIA</b> Philadelphia (610)941-1155 Pittsburgh (412)486-8488
<b>CONNECTICUT</b> (888) 506-5400	<b>MINNESOTA</b> Minneapolis (612)946-9510	<b>PUERTO RICO</b> Caguas (888) 506-5400
<b>DELAWARE</b> Philadelphia, PA (610)941-1155	<b>MISSISSIPPI Northern</b> Memphis, TN (901)276-0614	<b>RHODE ISLAND</b> N. Andover, MA (978)681-0451
<b>FLORIDA</b> Orlando (888) 506-5400	<b>MISSISSIPPI Southern</b> Jackson (888) 506-5400	<b>SOUTH CAROLINA</b> Greensboro, NC (336)854-1626
<b>FLORIDA Panhandle</b> (888) 506-5400	<b>MISSOURI</b> St. Louis (314)894-7800 Kansas City (888) 506-5400	<b>SOUTH DAKOTA</b> Minneapolis, MN (612)946-9510
<b>GEORGIA</b> Atlanta (404)256-5940	<b>MONTANA</b> Bozeman (406)587-0513	<b>TENNESSEE</b> Memphis (901)276-0614 Nashville (888) 506-5400
<b>HAWAII</b> (808) 623-2893	<b>NEBRASKA</b> Omaha (888) 506-5400	<b>TEXAS</b> Dallas (972)518-0004 Houston (713)686-5600
<b>IDAHO Northern</b> Spokane, WA (888)506-5400	<b>NEVADA Northern</b> Sacramento, CA (530)885-6591	<b>UTAH</b> Salt Lake City (801)973-7454
<b>IDAHO Southern</b> Salt Lake City, UT (801)973-7454	<b>NEVADA Southern</b> Phoenix, AZ (562)921-4423	<b>VERMONT</b> (888) 506-5400
<b>ILLINOIS Northern</b> Metro Chicago (888) 506-5400 Rockford (888) 506-5400	<b>NEW HAMPSHIRE</b> N. Andover, MA (978)681-0451	<b>VIRGINIA Southern</b> Richmond (888) 506-5400
<b>ILLINOIS Southern</b> St. Louis, MO (314)894-7800	<b>NEW JERSEY Northern</b> Leonia (201)461-7790	<b>VIRGINIA Northern</b> Baltimore, MD (888) 506-5400
<b>INDIANA</b> Indianapolis (888) 506-5400	<b>NEW JERSEY Southern</b> Philadelphia, PA (610)941-1155	<b>WASHINGTON</b> (888) 506-5400
<b>INDIANA Gary &amp; South Bend</b> Chicago, IL (888) 506-5400	<b>NEW MEXICO</b> (888) 506-5400	<b>WASHINGTON, D.C.</b> Baltimore, MD (888) 506-5400
<b>IOWA</b> (888) 506-5400	<b>NEW YORK</b> Albany (888) 506-5400 Buffalo (888) 506-5400 Rochester (888) 506-5400 Syracuse (888) 506-5400	<b>WEST VIRGINIA</b> (304)562-7058
<b>KANSAS</b> (888) 506-5400	<b>NEW YORK Metro NYC, L.I.</b> Leonia, NJ (201)461-7790	<b>WISCONSIN</b> (888) 506-5400
<b>KENTUCKY</b> Louisville (502)491-4215		<b>WYOMING</b> (888) 506-5400
<b>LOUISIANA</b> (888) 506-5400		

**For Information Call 888-506-5400 Ask for Ext. 7366**

**PANDUIT Products are available through Worldwide Subsidiaries and Distributors**

All Reference Dimensions in This Catalog are Shown in Inches and (Millimeters)  
Our products are warranted to be free from defects in material and workmanship at the time of sale but our obligation under this warranty is limited to the replacement of any product proved to be defective within 6 months (for product) or 90 days (for tools) from the date of delivery. Tool warranty is void if Panduit tools are modified, altered or misused in any way. Use of Panduit tooling with any product other than the specified Panduit products for which the tool was designed, constitutes misuse. Before using, user shall determine the suitability of the product for his intended use and user assumes all risk and liability whatsoever in connection therewith.

This warranty is made in lieu of and excludes all other warranties, expressed or implied. THE IMPLIED WARRANTIES OF MERCHANTABILITY AND FITNESS FOR A PARTICULAR USE ARE SPECIFICALLY EXCLUDED. Neither seller nor manufacturer shall be liable for any other injury, loss or damage, whether direct or consequential, arising out of the use of, or the inability to use, the product.

The information contained in this literature is based on our experience to date and is believed to be reliable. It is intended as a guide for use by persons having technical skill at their own discretion and risk. We do not guarantee favorable results or assume any liability in connection with its use. Dimensions contained herein are for reference purposes only. For specific dimensional requirements consult the factory. This publication is not to be taken as a license to operate under, or a recommendation to infringe any existing patents. This

Order number of pieces required in multiples of Std. Pkg. Qty.



Panduit Corp.  
17301 Ridgeland Avenue  
Tinley Park, IL 60477-3091  
Phone: 888-506-5400, Ext. 7366  
708-532-1800  
FAX: 770-781-9076  
Email: [info@panduit.com](mailto:info@panduit.com)  
Website: [www.panduit.com](http://www.panduit.com)

Panduit Canada  
Div. of Panduit Corp.  
140 Amber Street  
Markham, Ontario L3R 3J8  
Phone: 800-387-9689  
905-475-6922  
FAX: 905-475-6998

*For Pricing and Further Information —  
Contact your local authorized  
PANDUIT Distributor or Sales Office*

Printed in U.S.A.

WORLDWIDE SUBSIDIARIES AND SALES OFFICES

SA101N556-WA